

»multifix« series

Reversible diaphragm pressure regulators, independent of inlet pressure, with self-relieving design. The pressure setting can be locked by pushing the button down.

Max. input pressure:	16 bar
Medium temperature:	-10 to 60 °C
Ambient temperature:	-10 to 60 °C
Spring bonnet:	POM-brass
Sealant:	NBR
Flow rate measurement:	At $P_1 = 8$ bar, $P_2 = 6$ bar and pressure drop $\Delta p = 1$ bar
Internal air consumption:	Depending on secondary pressure

Pressure regulator incl. pressure gauge							
Art. No.	Type No.	Thread	Housing	Control range bar	Flow rate l/min	Size	DN
133098	R 44 - 6	G 3/4	Die-cast aluminium	0.2 - 6	12500	4	20

Accessories / spare parts		
Art. No.	Type No.	Description
135858	ZW 45	Mounting bracket with 2 screws
135857	KP 45	Coupler pack for modular assembly of several devices
135855	22.1845.4	Set of wearing parts

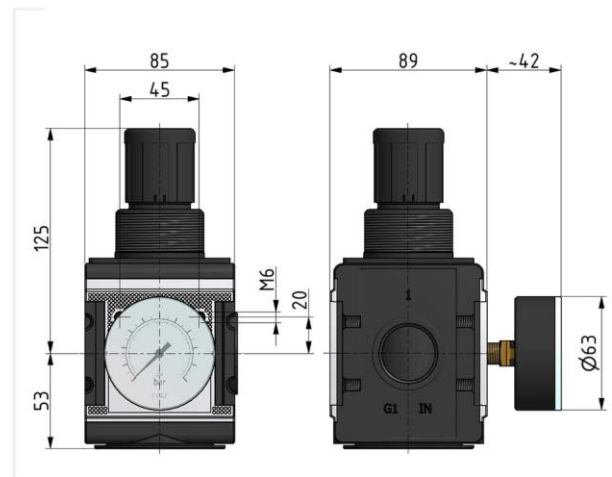

flow characteristic

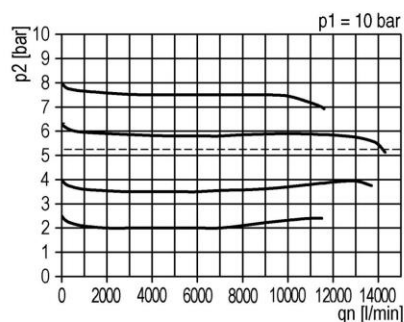

pressure characteristic

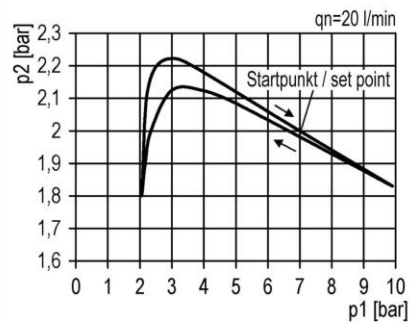

symbol

